



## COMPLETE CABINET CONFIDENCE

BUILD WITH CONFIDENCE

# Electronic switching devices and motor control

Reliable motor switching, protection, and monitoring



**MELBOURNE**  
2/2 Sibthorpe Street  
Braeside VIC 3195  
Ph: (03) 9587 1233  
sales@remtron.com.au

**GIPPSLAND**  
1/29-31 Eastern Road  
Traralgon VIC 3844  
Ph: (03) 5192 5000  
gippslandsales@remtron.com.au

**ALBURY**  
444 Wilson Street  
Albury NSW 2640  
Ph: (02) 6043 8400  
albursysales@remtron.com.au

**TASMANIA**  
5/2 Cessna Way  
Cambridge TAS 7170  
Ph: (03) 6422 5000  
remtron.tasmania@remtron.com.au

**ADELAIDE**  
22 Marlow Road  
Keswick SA 5035  
Ph: (08) 5192 5000  
sasales@remtron.com.au

**BRISBANE**  
2/3273 Logan Road  
Underwood QLD 4119  
Ph: (07) 3208 7931  
qldsales@remtron.com.au

**TOWNSVILLE**  
2/44-46 Carmel Street  
Garbutt QLD 4814  
Ph: (07) 4725 4499  
qldsales@remtron.com.au

# Switching devices and motor control

## The CONTACTRON product portfolio

Your partner for switching devices and motor control: Take advantage of Phoenix Contact's broad portfolio of electronic switching devices, economical motor and machine managers, the modular power distribution system, and speed starters with intuitive operation.

We will also support you in meeting the challenges of digitalization, optimizing production and operational costs, Industry 4.0, and energy management.

4

### Motor and machine management

Economic protection and monitoring: detection of all critical load conditions and precise energy measurement of motors and other machines.

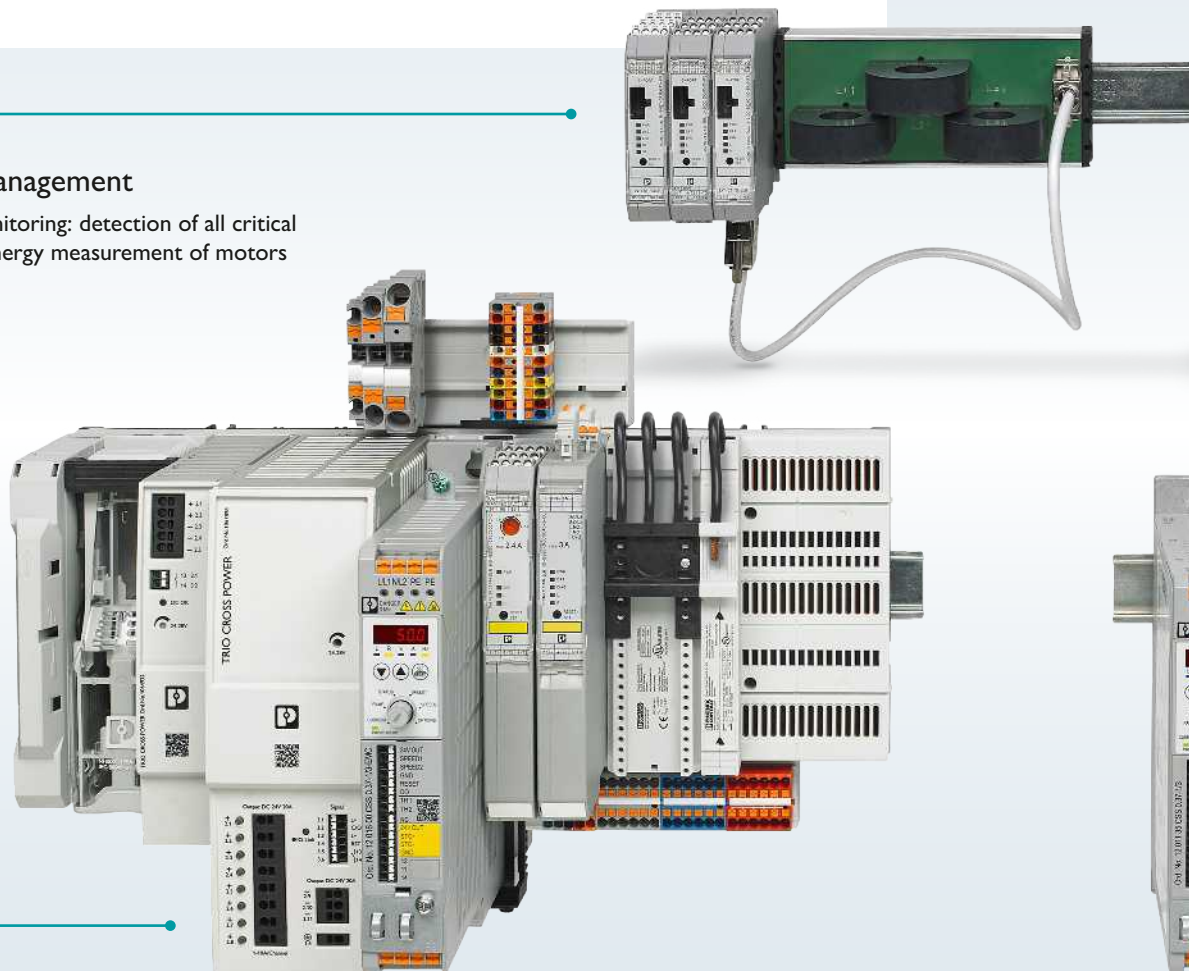

6

### Power distributors – CrossPowerSystem

CrossPowerSystem is an open platform for modular and functional control cabinets. Three-phase devices are mounted on the power distributor via Plug and Play.

3

### Solid-state contactors

Reliable and fast switching of AC and DC loads.



5

### INTERFACE system

Easily transfer process data, quickly network devices and integrate them into the fieldbus system in order to reliably detect the motor status and all load states of motors and systems.

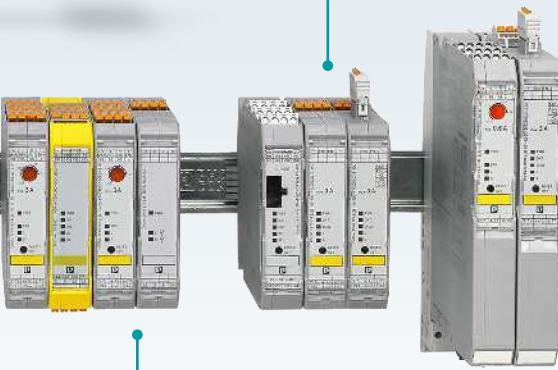

1

### Motor starters

Switch motors smartly: Switch and reverse motors quickly and reliably with the compact CONTACTRON hybrid motor starters.



2

### Speed starters

Connect, set, start: CONTACTRON Speed Starter, the new device class with intuitive operation for soft start, different speeds, motor protection, and Safe Torque Off.

## Contents

CONTACTRON motor starters	4
Hybrid technology	6
Hybrid motor starters – stand-alone	8
Hybrid motor starters – modular	10
Hybrid motor starters – network-capable	12
CONTACTRONSpeed Starter	16
Solid-state contactors	22
For controlling DC motors	24
For controlling AC motors	26
CONTACTRON motor and machine management	28
Motor manager	30
Machine manager	32
INTERFACE system	34
Power distributors CrossPowerSystem	38
COMPLETE line – the comprehensive solution for the control cabinet	46

The new standard for the control cabinet. More information is available on pages 46 to 47.

# CONTACTRON

## motor starters

1

Switch motors safely and reliably with compact stand-alone, modular, and network-capable hybrid motor starters. The devices can be used wherever three-phase asynchronous motors, from 50 W to 3 kW, need to be reversed and protected. The product range of hybrid motor starters consists of direct and reversing starters which are available with various functions such as emergency stop and motor protection.



### Hybrid motor starters – stand-alone

The product range of hybrid motor starters consists of direct and reversing starters that are available with various functions such as emergency stop and motor protection.

Versions with short-circuit protection:

With the integrated fuses, the motor starters meet coordination type 2 in accordance with IEC/EN 60947-4-2. These devices can be mounted flexibly on standard DIN rails or on 60 mm power busbars.

### Hybrid motor starters – modular

CONTACTRON pro is the new version of the CONTACTRON product range offering simple safety integration and modular extension options. Everything on the basis of hybrid technology – for an increased level of simplicity in functional safety, high system availability, and easy handling.

	Stand-alone	Modular	Network-capable
Direct and reversing starters*	•	•	•
Motor protection and emergency stop*	•	•	•
Short-circuit protection	•		
Modular extension possible		•	•
Network-capable			•
<b>Diagnostic functions</b>			
Checkback contact	•	•	
Error code display**	•	•	•
Additional relay module for status checkback		•	
Early warning in the case of overload			•
<b>DIN rail connectors</b>			
Group switch-off		•	
24 V power supply		•	•
Data transmission			•

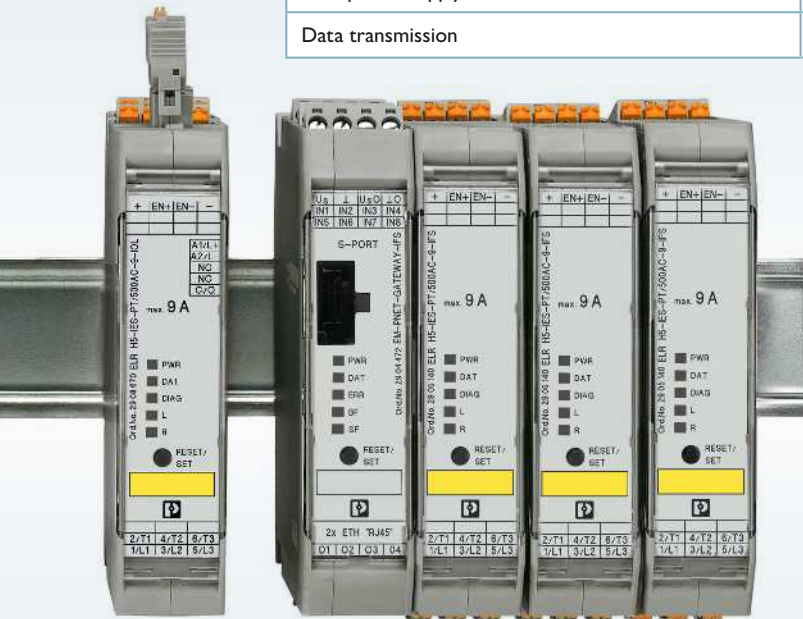

## CONTACTRON Hybrid Technology <sup>®</sup>

Designed by PHOENIX CONTACT

### Hybrid motor starters – network-capable

Integration into fieldbus systems is realized via the interface system connection. Corresponding gateways are available for all common fieldbus systems. The IO-Link versions enable you to benefit from consistent communication between the field and control level, thereby enabling the easy transfer of process data.



# CONTACTRON

## Hybrid technology

CONTACTRON hybrid technology is a microprocessor-controlled combination of wear-free solid-state technology and robust relay technology. The semiconductors execute the wear-prone on and off switching operations, while the relays only conduct low-loss current. This enables soft switching and considerably reduces the load on the relay contacts.

### CONTACTRON Hybrid Technology

Designed by Phoenix Contact

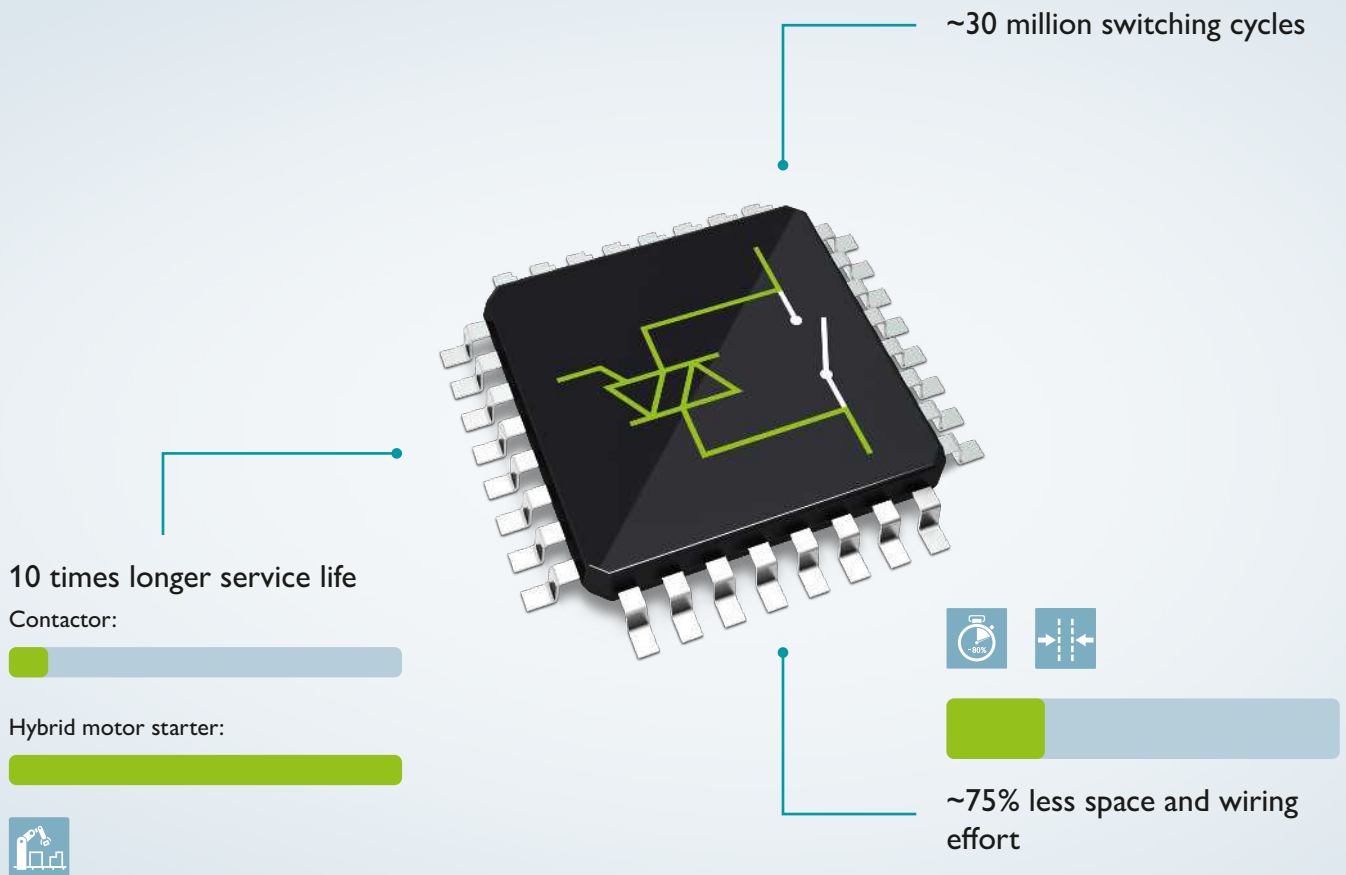

# Technology in comparison

## CONTACTRON compared to traditional solutions

- CONTACTRON integrates the functions of a conventional reversing contactor, including safety function, into a single device up to Cat.4 / PL e, SIL 3 depending on the module
- Internal load and locking circuits enable clear wiring
- The locking circuit is certified in accordance with UL 508a and UL 60947-1

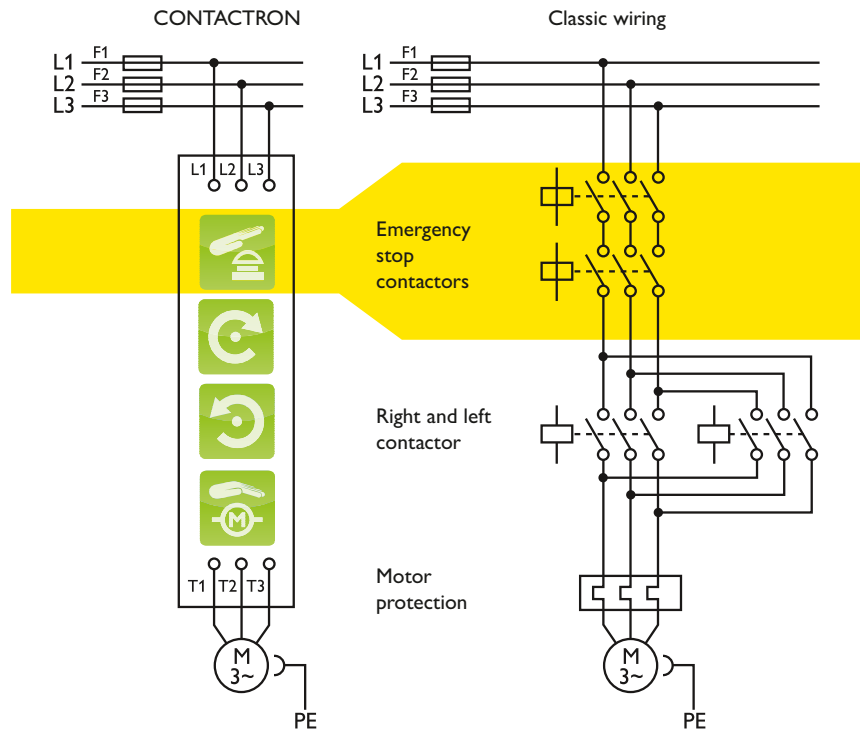

## Less space required in comparison to standard switching devices

Using the CONTACTRON hybrid motor starter, device combinations that would previously take up a lot of space in the

control cabinet can now be replaced with one single device.

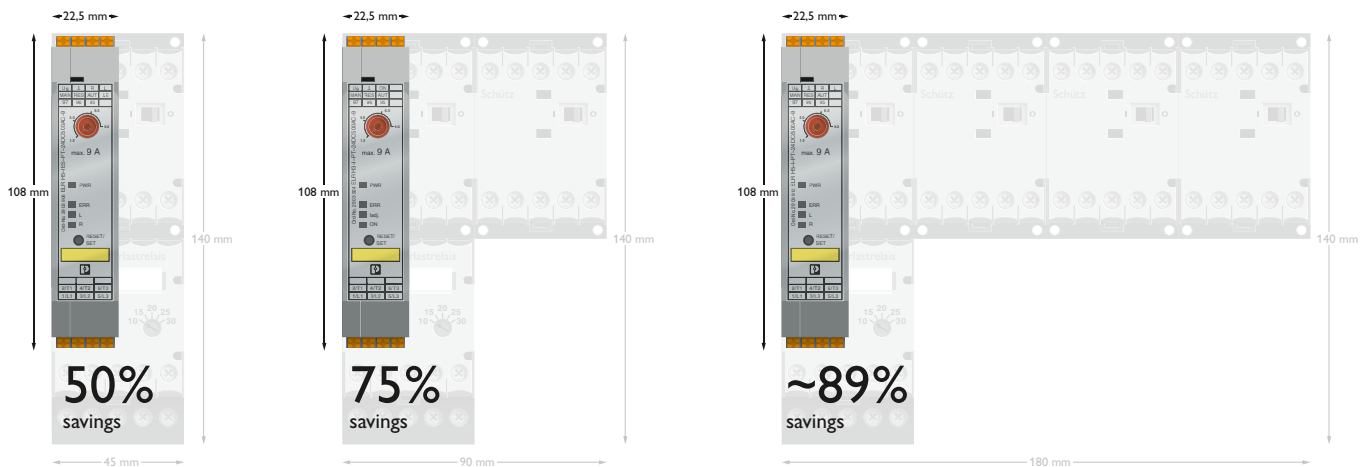

# CONTACTRON

## Hybrid motor starters – stand alone

Switch motors quickly and reliably with the compact hybrid motor starters. The devices can be used wherever three-phase asynchronous motors, from 50 W to 3 kW, need to be reversed and protected. The product range of hybrid motor starters consists of direct and reversing starters which are available with various functions such as emergency stop and motor protection.



## CONTACTRON Hybrid Technology

Designed by PHOENIX CONTACT



### Your advantages

- ✓ Less space required with the narrow design: 22.5 mm overall width
- ✓ Easy wiring with integrated locking circuit and load wiring
- ✓ Service life up to 10 times longer with gentle switching with the CONTACTRON hybrid motor starter technology
- ✓ Adjustable motor protection with bimetal function up to 9 A
- ✓ Safe shutdown with integrated safety function up to SIL 3 and PL e



# Intelligent switching and reliable protection

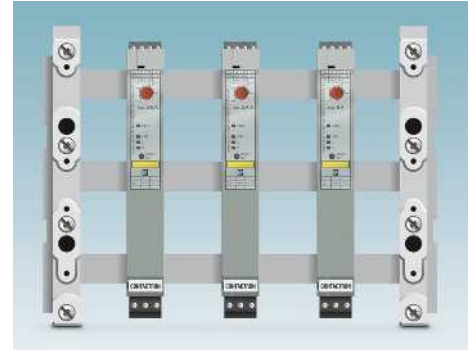

## Easy diagnostics

The device visualizes the operating states with a total of four LEDs (overload, underload, symmetry, etc.), thus ensuring simple diagnostics.

## Integrated short-circuit protection

With the integrated fuses, the motor starters meet coordination type 2 in accordance with IEC/EN 60947-4-2. These devices can be mounted flexibly on standard DIN rails or on 60 mm power busbars.

## Mounting adapters for power busbars

Hybrid motor starters can be flexibly mounted using a mounting adapter.

This provides many advantages:

- Mounting directly on a standard DIN rail or power busbar
- Safe disconnection of motor outputs
- Safely disconnected from the mains voltage: by simply removing the switching device from the mounting adapter, for maintenance and servicing

## Cost-efficiency with needs-based function selection



### Forward running

Easy control directly via 24 V PLC output cards or 230 V AC signal.



### Reverse running

Optional: reversing function including locking circuit and load wiring.



### Motor protection

Convenient protection with the electronic motor protection relay with automatic and remote reset function.



### Emergency stop

The integrated safety function enables use in safety-related emergency stop applications.

# CONTACTRON

## Hybrid motor starters – modular

CONTACTRON pro is the new version from the CONTACTRON family offering simple safety integration and modular extension options. Everything on the basis of hybrid technology – for an increased level of simplicity in functional safety, high system availability, and easy handling.



## CONTACTRON Hybrid Technology <sup>3</sup>

Designed by PHOENIX CONTACT



# Simplicity in functional safety



## Easy group shutdown

The upstream safety relay guarantees a secure stop of the connected motors after an emergency stop up to performance level e. Our TÜV-certified modules make functional safety very easy for you.



## Easy handling

With the economical DIN rail connector, you save on wiring effort, which means you save money as well: Reap the benefits of easy signal loop-through (24 V power supply, ground and enable) plus expansions with checkback contacts.



## Reliable feedback

Additional feedback on the motor status you can rely on: With an optional relay module you can reliably capture the status of the motor, e.g. forward or reverse running.

## Application example

Using the DIN rail connector, you can perform an emergency stop group switch-off of all the downstream hybrid motor starters without the need for additional wiring. In addition, all modules can be supplied from the system power supply. The optional response module makes it possible to monitor the motor function.

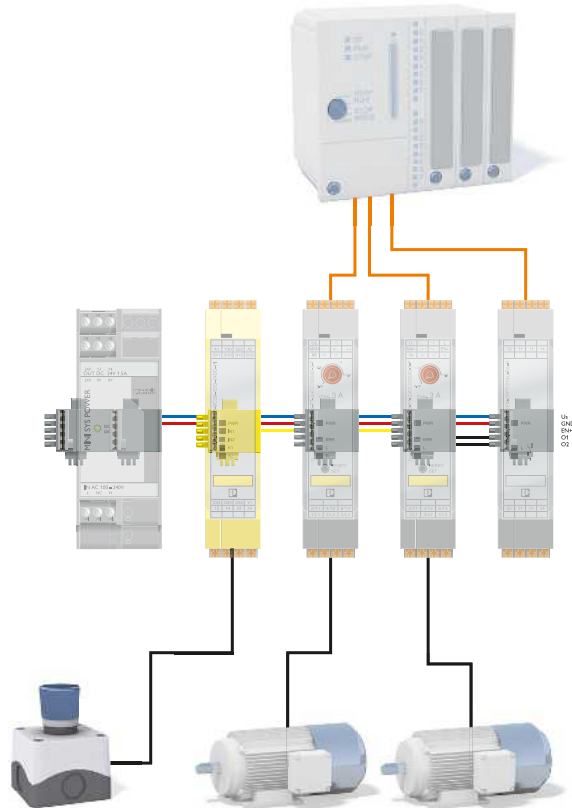

CONTACTRON

## Hybrid motor starters – network-capable

Integration into fieldbus systems is realized via the interface system connection. Corresponding gateways are available for all common fieldbus systems. Transfer your process data easily and network your devices within the framework of digitalization and Industry 4.0 quickly, both with the interface system (IFS) and also the available IO-Link versions.



CONTACTRON Hybrid Technology <sup>3</sup>

Designed by PHOENIX CONTACT



# Easy networking



## Gateway

Up to 32 IFS devices can be easily integrated into conventional fieldbus systems and save bus addresses for field devices. The gateway is configured via the intuitive IFS-CONF software.

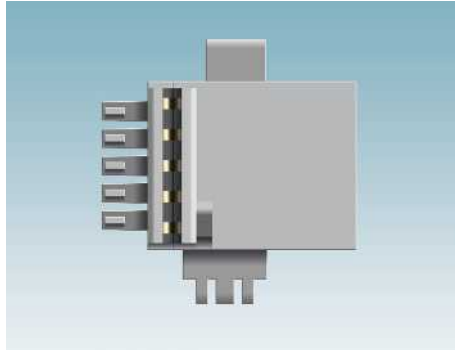

## DIN rail connectors

The easy-to-assemble solution for networking, communication, data transmission, and 24 V power supply.



## Easy diagnostics

Transfer of status messages to the controller, e.g. overload, underload advance warning, symmetry, etc.

## Consistent networking via the interface system or IO-Link

The new network-capable versions enable consistent communication between the field and control level. Integration into all

common fieldbus systems is realized via the interface system or IO-Link.

**i** Web code: #1994

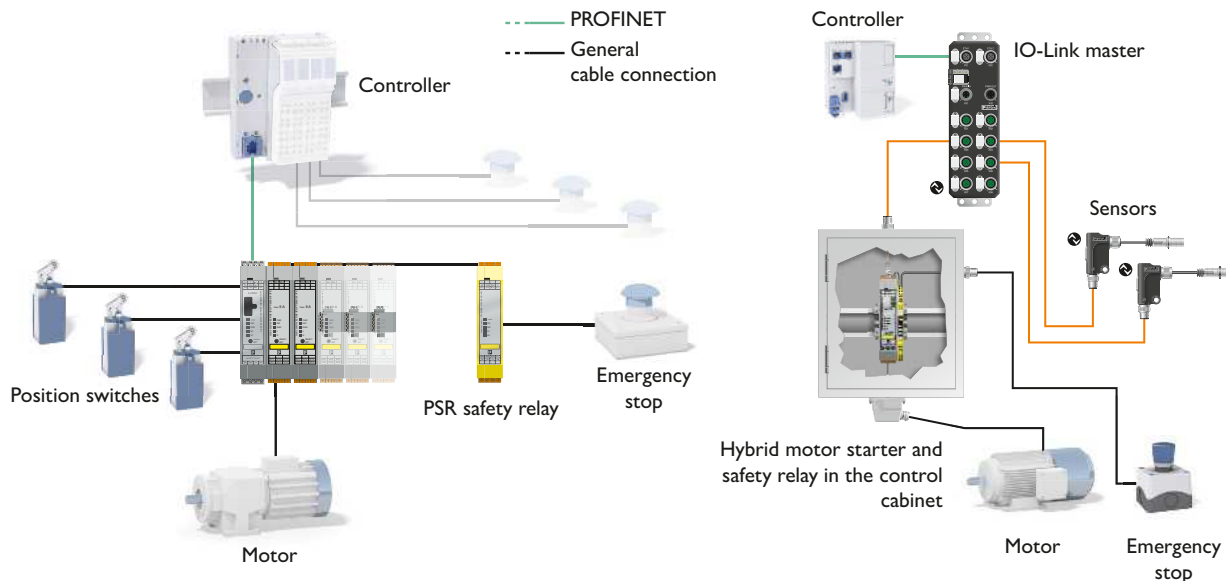

# Motor starters – product overview

Stand-alone motor starters									
Max. load current	Input voltage	Functions						Push-in connection	Screw connection
		Direct starter	Reversing starter	Emergency stop	Motor-reversing	ATEX	Short-circuit protection		
0.6 A	24 V DC	•						2903920	2900542
		•		•		•		2903914	2900566
			•		•			2903908	2900573
			•	•	•	•		2903902	2900582
			•	•	•	•	•		2902746
2.4 A	230 V AC	•		•		•			2900568
			•	•	•	•			2900420
	24 V DC	•							2903922
		•		•		•		2903916	2900567
			•		•			2903910	2900574
			•	•	•	•		2903904	2900414
			•	•	•	•	•		2902744
9 A	230 V AC	•		•		•			2900570
			•	•	•	•			2900422
	24 V DC	•							
		•						2903924	2900545
		•		•		•		2903918	2900569
			•		•				2900538
			•		•			2903912	2900576
			•	•	•	•	•	2903906	2900421
			•	•	•	•	•		2902745

# Motor starters – product overview

1

2

3

4

5

6

CONTACTRON

Modular motor starters										
Max. load current	Input voltage	Functions						Push-in connection	Screw connection	
		Direct starter	Reversing starter	Emergency stop	Motor-reversing	ATEX	Modular			
3 A	24 V DC	•					•	2909563	2908696	
		•		•			•	2909570	2908700	
		•		•		•	•	2909557		
			•		•		•	2909562	2908695	
			•	•	•		•	2909569	2908699	
9 A			•		•			•	2909556	
		•						•	2909561	2908694
		•		•				•	2909568	2908698
		•		•		•	•	•	2909555	
			•		•		•	•	2909560	2908693
		•	•	•		•	•	2909567	2908697	
		•	•	•	•	•	•	2909554		

Network-capable motor starters										
Max. load current	Input voltage	Functions						Push-in connection	Screw connection	
		Direct starter	Reversing starter	Emergency stop	Motor-reversing	ATEX	Network-capable			
0.6 A	24 V DC	•		•		•	•	2905141	2905154	
		•					•	2905148		
			•	•	•	•	•	•	2905138	2905151
			•		•			•	2905144	2905157
3 A			•		•		•	•	2905142	2905155
		•						•	2905149	2905163
			•	•	•	•	•	•	2905139	2905152
			•		•			•	2905146	2905159
9 A			•		•		•	•	2905143	2905156
		•						•	2905150	2905164
		•	•	•	•	•	•	2905140	2905153	
		•		•		•	•	2905147	2905160	

# Speed Starter

## Simple, efficient, and safe

The CONTACTRON Speed Starters are available in a wide range of versions: Performance classes between 0.25 and 1.5 kW, with and without EMC filter, and with 1- or 3-phase mains input. Select the appropriate product for your application.

**Push-in Technology**  
Designed by Phoenix Contact

### Intuitive operating concept

With the simple operator interface consisting of a rotary switch, three buttons, and a display, all necessary settings can be made particularly intuitively.

### Safe Torque Off (STO)

With the integrated STO function, the CONTACTRON Speed Starter is unique in its device class. This means that you benefit from two-channel, safe shutdown without complex procedures and without additional contactors. SIL 3 and PLe certifications provide for your safety.

### Versions with fans

Particularly service-friendly due to the replaceable fan.

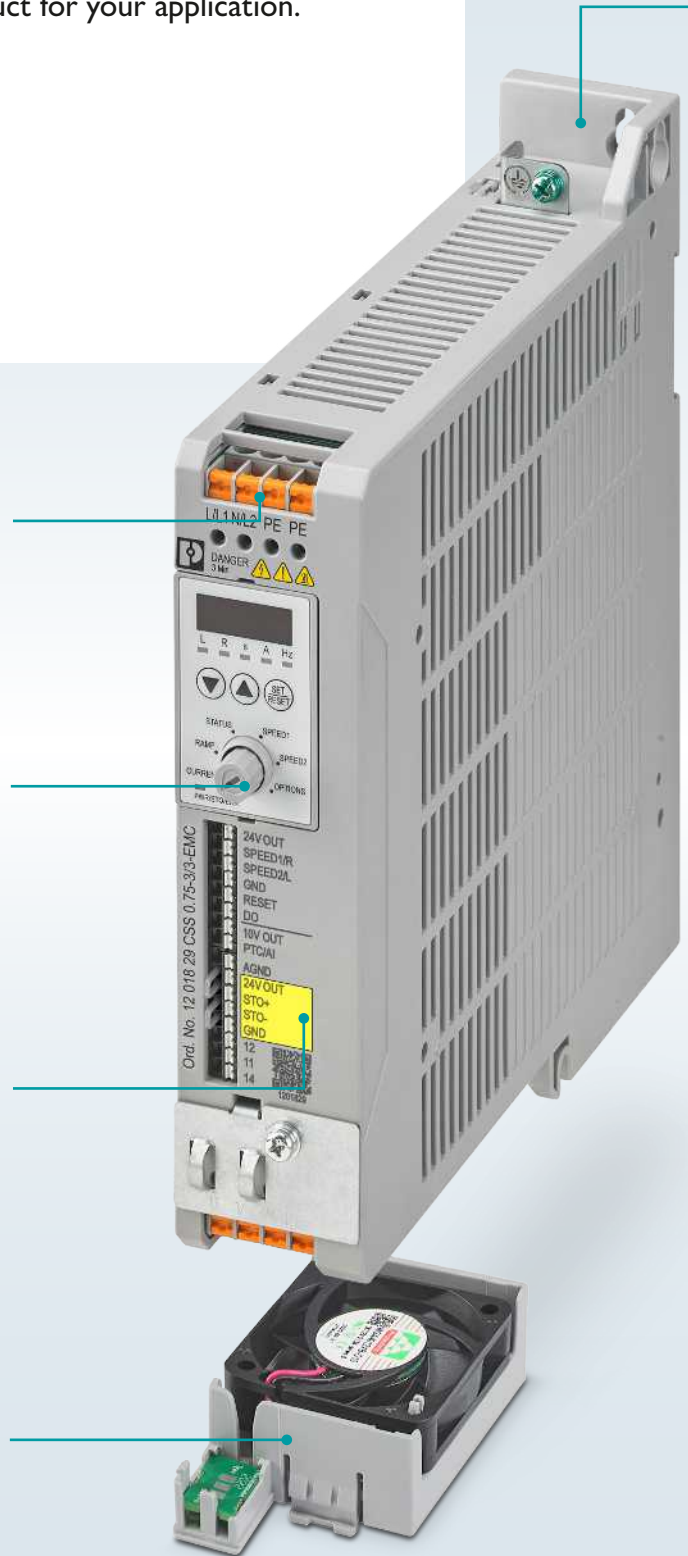



## Quick installation and startup

The Plug and Play solution provides you with an easy commissioning option. Set the required parameters quickly and efficiently via the rotary switch and the buttons. Currently the narrowest device of its class on the market. Higher density in the control cabinet will save you additional costs.

## DIN rail mounting

The devices can be mounted on and removed from the DIN rail without the use of tools.

## Rear panel mounting

Due to the mounting apparatus, the devices can be attached to the rear panel from the front, in the classic way, or from the side.

## Saving space in the control cabinet

In a compact design with an overall width starting at just 35 mm, the CONTACTRON Speed Starter is currently the narrowest device in its class available on the market. Higher density in the control cabinet will save you additional costs.

## Versions with heatsink

Cooling the devices without wear or noise.

## Performance class 0.25–1.5 kW

## Analog input

For even more flexibility in terms of speed.

## Shroud for control lines

## Shroud for motor feeder lines

Optional mount on the shroud for control lines for supporting the shroud of the motor feeder lines.

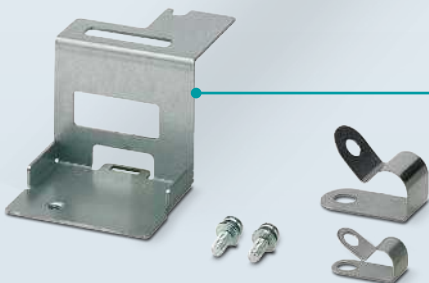

# Speed starter with intuitive operation – CONTACTRON Speed Starter

The speed starter, with particularly intuitive operation, is the device class between motor starters and complex frequency converters. This compact solution provides all of the functions necessary for different speeds, soft start, and safe stopping with the Safe Torque Off (STO) function.

## Your advantages

- ✓ Quick installation and startup with easy wiring and intuitive operation concept
- ✓ Safe shutdown with the integrated Safe Torque Off function (STO)
- ✓ Space savings in the control cabinet due to the compact design with an overall width starting at only 35 mm
- ✓ Cost-effective solution with all functions necessary for different speeds and soft start



# Safe, narrow, and cost-effective

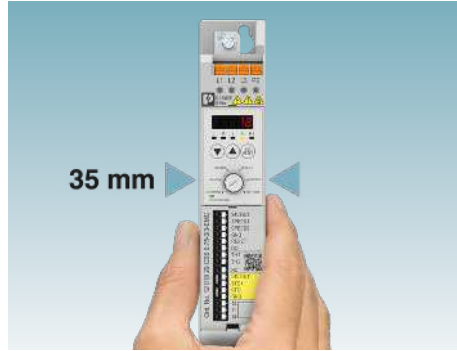

## Safe shutdown

Thanks to the integrated Safe Torque Off function (STO), the CONTACTRON Speed Starter is unique in its device class. Thus, you benefit from two-channel, safe shutdown without complex procedures and without additional contactors. SIL 3 and PLe certifications provide for your safety.

## Saving space in the control cabinet

In a compact design with an overall width starting at just 35 mm, the CONTACTRON Speed Starter is currently the narrowest device in its class available on the market. Higher density in the control cabinet will save you additional costs.

## Cost-effective solution

The new speed starter has all the basic functions of CONTACTRON motor starters that you need: start, reverse rotation, overload protection, and safe shutdown of three-phase asynchronous motors. You can realize different speeds as well as the soft start and stop of the motor at full torque. You get the exact functionality you need.

## Application example

Speed profile:

1. To avoid high starting currents, such as in the case of large fans, a soft start can be used for the motor.
2. A conveyor belt is carefully decelerated by the ramp function (to avoid a collision).
3. Normal speed for a fast transport phase and creeping speed for a slow positioning phase.
4. Efficient operation of motors in accordance with the EUP Lot directive (energy efficiency directive).



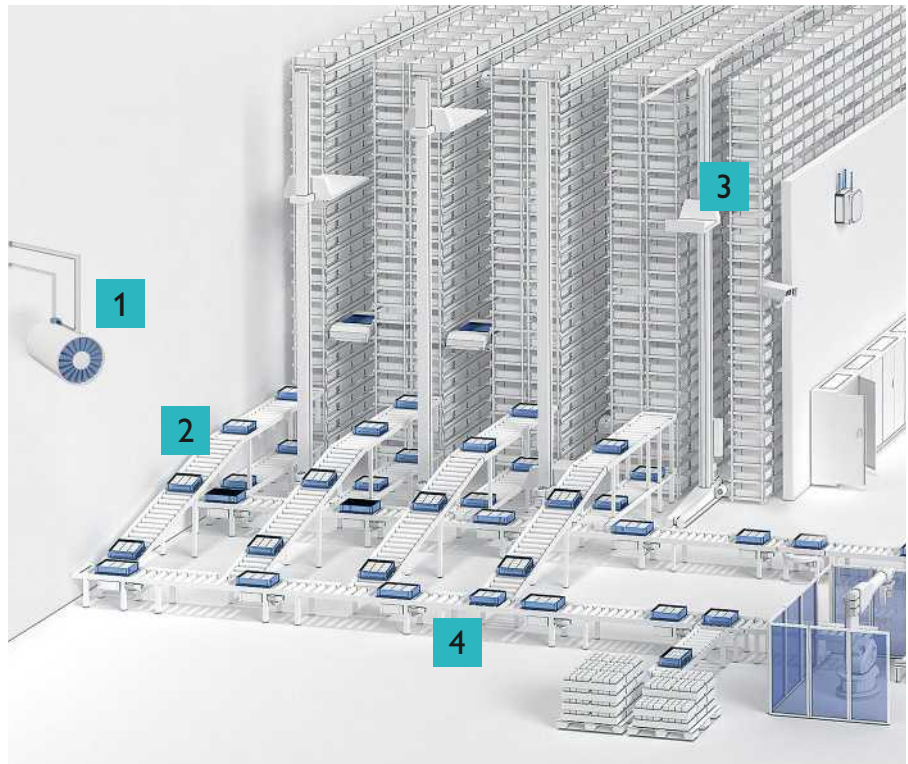

The CONTACTRON Speed Starter provides simple operation with various speeds, from normal speed and creeping speed all the way to energy efficiency and ramp functions.



# Speed starters – product overview

Single-phase load input								
Power	Nominal current		EMC protection	Housing	Cooling	Overall width	Depth	Item number
	Input	Output						
0.25 kW	3.5 A	1.7 A	Without EMC filter	A1	Heatsink	35 mm	175 mm	<a href="#">1201132</a>
0.37 kW	5.3 A	2.5 A		B1 heatsink		45 mm		190 mm
0.55 kW	6.7 A	3.2 A					B1 fan	
0.75 kW	9.1 A	4.3 A		<a href="#">1201509</a>				
1.5 kW	15.8 A	7.5 A		<a href="#">1201511</a>				
0.25 kW	3.5 A	1.7 A	With EMC filter	A2	Fan	35 mm	195 mm	<a href="#">1201520</a>
0.37 kW	5.3 A	2.5 A		B2		45 mm		210 mm
0.55 kW	6.7 A	3.2 A					<a href="#">1201602</a>	
0.75 kW	9.1 A	4.3 A		<a href="#">1201613</a>				
1.5 kW	15.8 A	7.5 A		<a href="#">1201642</a>				

Three-phase load input								
Power	Nominal current		EMC protection	Housing	Cooling	Overall width	Depth	Item number
	Input	Output						
0.25 kW	1 A	0.9 A	Without EMC filter	A1	Heatsink	35 mm	175 mm	<a href="#">1201679</a>
0.37 kW	1.7 A	1.5 A		B1 heatsink		45 mm		190 mm
0.55 kW	2 A	1.8 A					B1 fan	
0.75 kW	2.8 A	2.5 A		<a href="#">1201695</a>				
1.5 kW	4.2 A	3.9 A		<a href="#">1201650</a>				
0.25 kW	1 A	0.9 A	With EMC filter	A2	Fan	35 mm	195 mm	<a href="#">1201713</a>
0.37 kW	1.7 A	1.5 A		B2		45 mm		210 mm
0.55 kW	2 A	1.8 A					<a href="#">1201828</a>	
0.75 kW	2.8 A	2.5 A		<a href="#">1201829</a>				
1.5 kW	4.2 A	3.9 A		<a href="#">1201696</a>				

Overview of housing types					
					
Housing	A1	A2	B1 heatsink	B1 fan	B2
Cooling	Heatsink	Fan	Heatsink	Fan	
Width	35 mm			45 mm	
Height	210 mm				
Depth	175 mm	195 mm	190 mm		210 mm

## Accessories – product overview

1

2



3





4

5

6

Speed Starter

Fan			
	Description	Item number	Type
	Replaceable fan for 35 mm wide CONTACTRON Speed Starters	1276911	EM-CSS-FAN-35
	Replaceable fan for 45 mm wide CONTACTRON Speed Starters	1276912	EM-CSS-FAN-45

Shroud			
	Description	Item number	Type
	Shroud for motor lines for 35 mm wide CONTACTRON Speed Starters	1276914	EM-CSS-MOTORSHIELD-35
	Shroud for motor lines for 45 mm wide CONTACTRON Speed Starters	1276916	EM-CSS-MOTORSHIELD-45
	Shroud for control lines for 35 mm wide CONTACTRON Speed Starters	1276904	EM-CSS-CONTROLSHIELD-35
	Shroud for control lines for 45 mm wide CONTACTRON Speed Starters	1276909	EM-CSS-CONTROLSHIELD-45

CPS adapter			
	Description	Item number	Type
	Adapter for CONTACTRON Speed Starter for direct mounting on the CrossPowerSystem power distribution board	1282859	EM-CPS-DA-45C-CSS

# Solid-state contactors

3

Solid-state contactors are far superior to mechanical contactors in terms of switching speed, service life, and robustness. Use different versions for controlling DC and AC motors in a variety of applications.

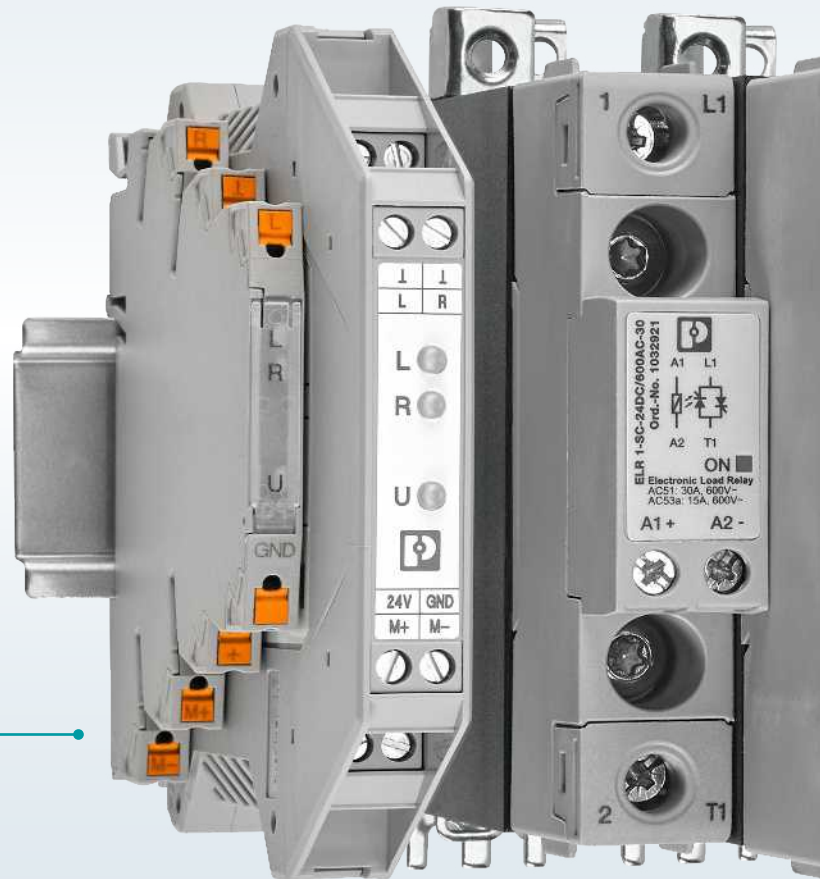

## DC solid-state contactors

The DC solid-state contactors are designed for DC motors up to 24 V/6 A and are available in two widths (6.2 and 12.5 mm). Benefit from high system availability with reliable and fast switching with wear-free electronics.

Output	DC solid-state contactors			AC solid-state contactors					
	24 V DC			1-phase			3-phase		
Power [A]	2	2	6	20	30	50	2	9	37
Overall width [mm]	6.2	12.5		17.8		35	40	67.5	147.5
Direct start	•*	•*		•			•		
Reversing start	•	•					•		

\*) Two independent loads could be switched.

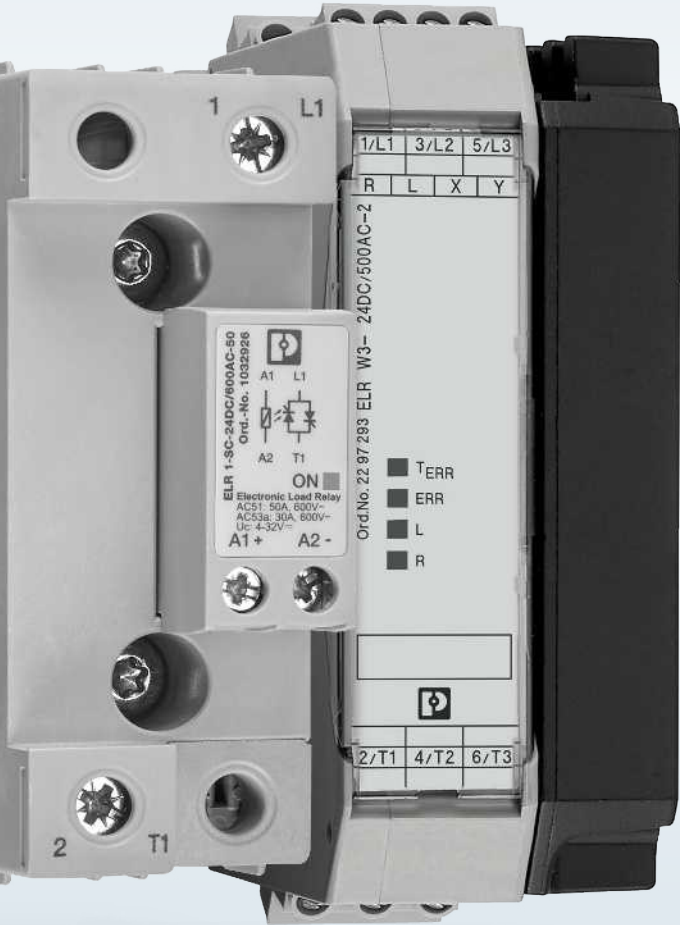

### AC solid-state contactors

The AC solid-state contactors from the CONTACTRON series are available for single and three-phase networks and in various performance classes and, depending on the type, also provide a reversing function.

## Solid-state contactors

# For controlling DC motors

Electronic load relays and reversing load relays enable the fast switching of mechanically commutated DC motors. Our reversing load relays switch and brake DC motors up to 24 V/6 A without wear. An output protected against short circuits, surge voltages, and overloads ensures reliable operation in the system. The internal locking circuit and load wiring minimize the wiring effort.



### Your advantages

- ✓ High system availability with reliable and fast switching with wear-free electronics
- ✓ Easy wiring with integrated locking circuit and load wiring
- ✓ Direct start and reversing of mechanically commutated DC motors
- ✓ Robust and resistant to shocks and vibrations
- ✓ Reliable operation with short-circuit, surge, and overload-proof output



# Features

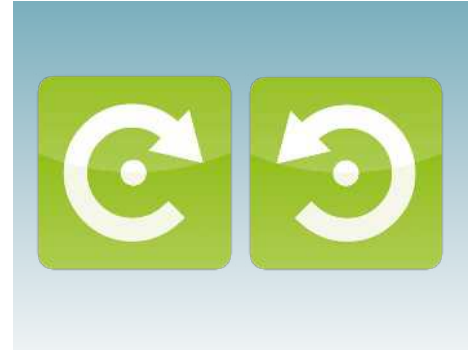
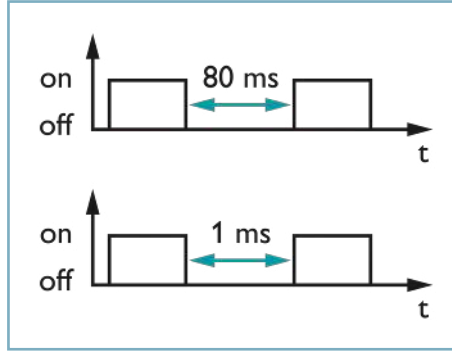
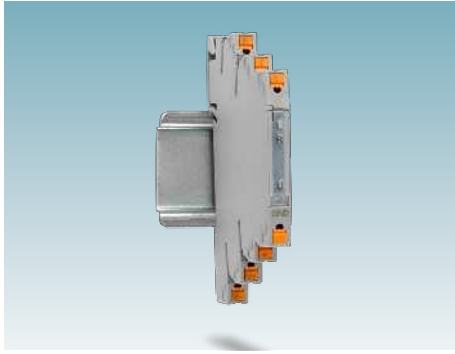

## Space saving

Compact version with a 6.2 mm design for optimum space saving in the control cabinet.

## Versions for high-frequency switching operations

Switching times of 1 ms to 80 ms for a variety of applications.

## Forward running and reverse running

Easy control via a 24 V DC signal. Locking circuit and load wiring included.

## A compact and simple solution for your goods transport and material flow

DC motors play a key role within intralogistics and conveying technology. As a compact solution, they ensure simple and low-wear goods transport and material flow.

High-frequency switching operations enable fast response times, for example in solenoid valves or points within the transport system.

With the two-channel control of the electronic load relay, two solenoid valves, for example, can be switched independently or a motor can be reversed.



## Electronic load relays for controlling DC motors

Max. load current	Input voltage	Functions	Switching delay	Overall width	Push-in connection	Screw connection
		Reversing starter				
2 A	24 V DC	•	80 ms	6.5 mm		2980539
		•	80 ms	6.5 mm	1069556	
		•	80 ms	12.5 mm		2963598
6 A		•	80 ms	12.5 mm		2982090
		•	1 ms	12.5 mm		2982757

## Solid-state contactors

# For controlling AC motors

Solid-state contactors switch resistive and inductive loads silently and without wear. The AC solid-state contactors from the CONTACTRON series are available for single and three-phase networks and, depending on the type, also provide a reversing function. Benefit from the semiconductor technology particularly in applications with a high switching frequency or when switching high alternating currents.



## Your advantages

- ✓ Reliable and fast switching with wear-free electronics
- ✓ Robust – resistant to shocks and vibrations
- ✓ Easy wiring with integrated locking circuit and load wiring
- ✓ Switching capacity up to 18.5 kW
- ✓ Direct start and reversing of three-phase asynchronous motors

# Wear-free switching

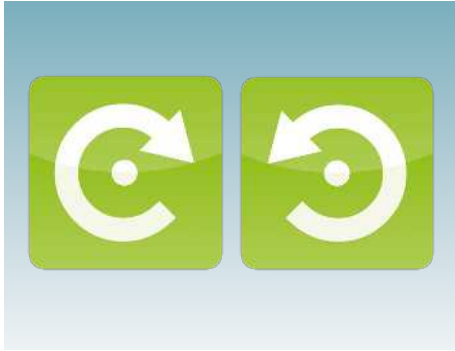

## Forward running and reverse running

Easy control via a 24 V DC or 230 V AC signal. Locking circuit and load wiring included.



## 1-phase solid-state contactors

Wear-free switching of 1-phase AC loads up to 660 V AC/50 A, e.g. production machines and heating systems.



## 3-phase solid-state contactors

Wear-free starting and reversing of 3-phase AC motors 575 V AC/3 x 37 A, e.g. in conveyor systems.

## Applications with high switching frequency and switching rate

Solid-state contactors are particularly suitable for high switching frequencies, such as boilers, temperature controllers or light and lighting systems.

Solid-state contactors can also be used to switch production machines, conveyor systems, machine tools, sliders, pumps, fans, separators or ship steering gear.

### Switching large AC loads

Error-free switching in the power grid: Solid-state contactors from Phoenix Contact only switch in zero crossing mode. This means that no high-frequency disturbing pulses are generated.



## Solid-state contactors

Max. load current	Input voltage	Functions			Overall width	Screw connection
		Grid type	Direct starter	Reversing starter		
20 A	24 V DC	1-phase	•		18 mm	<a href="#">1032919</a>
	230 V AC		•		18 mm	<a href="#">1032920</a>
30 A	24 V DC		•		18 mm	<a href="#">1032921</a>
	230 V AC		•		18 mm	<a href="#">1032922</a>
50 A	24 V DC		•		35 mm	<a href="#">1032926</a>
	230 V AC		•		35 mm	<a href="#">1032927</a>
2 A	24 V DC	3-phase		•	40 mm	<a href="#">2297293</a>
9 A				•	67.5 mm	<a href="#">2297316</a>
37 A				•	147.5 mm	<a href="#">2297374</a>

# CONTACTRON

## motor and machine management

4

**Protect your motors and systems:** The motor manager from Phoenix Contact combines overload and underload detection in a single device. In the event of an emergency, it protects the motor and shuts down the drive.

**Monitor your motors and machines:** Electronic machine management combines precise energy measurement with the display and monitoring of important parameters of motors, machines or other 3-phase consumers.

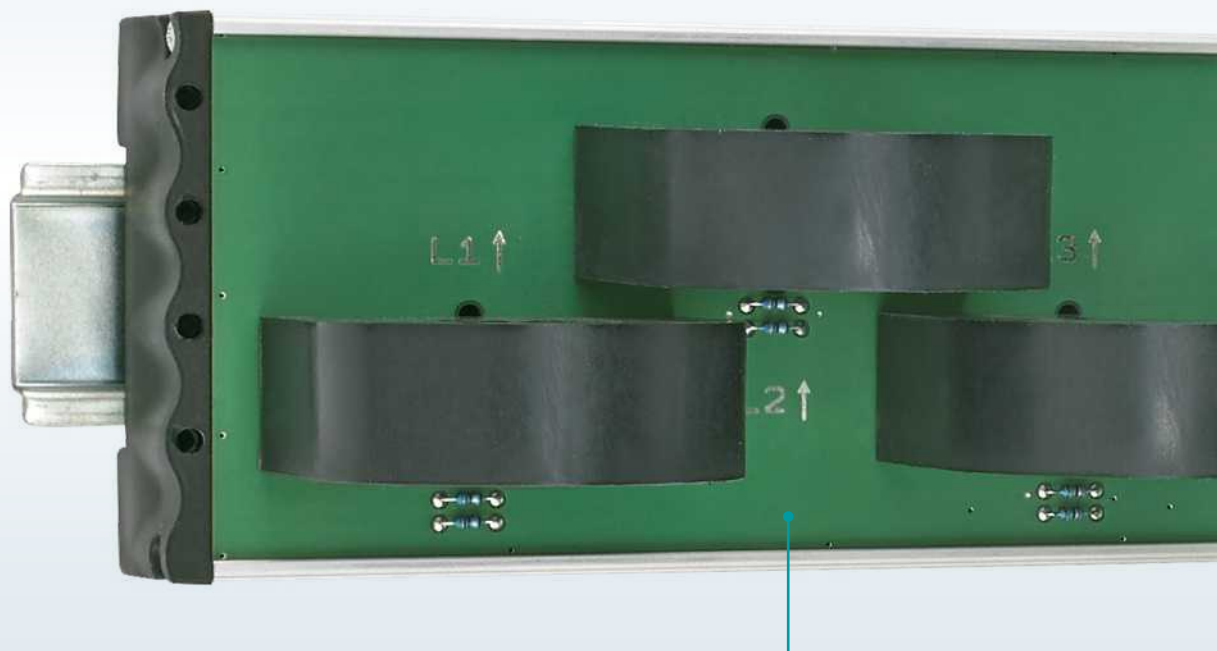

### Machine manager

By combining the electronic machine manager and an external current transformer, you can cost-effectively monitor motors, machines, and 3-phase loads.

Two versions are available with current ranges up to 90 A and 160 A.

	Motor manager	Machine manager
Measurement of electrical parameters (U, I, P, cos phi, S, Q, f)*	•	•
Monitoring of sinusoidal loads (e.g. asynchronous motors)	•	•
Monitoring of mixed loads (FU-controlled motors, complete systems)		•
Process data-based predictive maintenance (motors)	•	•
Process data-based predictive maintenance (systems)		•
Measuring range (max.)	5000 A**	160 A
Measuring accuracy	2%	0.50%
Monitorable values (incl. message and error message)	8	8
<b>Meters</b>		
Total energy meter	•	•
Operating hours counter	•	•
<b>Measuring system</b>		
Internal current transformer	Up to 16 A	
Use of external current transformers	•	•
<b>Motor outputs</b>		
Motor output configuration (signal)	•	•

\* Voltage, current, active power, cos phi, apparent power, reactive power, frequency  
 \*\* Depending on the transformer used



### Motor manager

Motor managers from Phoenix Contact monitor motors for overload and underload, function, dirt, and wear. You can therefore provide permanent protection for pumps, actuating drives, fans, conveyor belts and machine tools, for example.

## Motor and machine management

# Motor manager

With the motor manager, you can detect all the critical load states throughout the system and benefit from the advantages of modern real power monitoring. If required, the motor manager switches the drive off and thereby protects the motor and system. The motor manager is configured via the intuitive IFS-CONF software from Phoenix Contact.



### Your advantages

- ✓ Integrated full motor protection with bimetal function and thermistor evaluation
- ✓ Protection of high-quality system parts with freely configurable signaling and switching thresholds
- ✓ Production data and energy data acquisition without complex sensors
- ✓ Process data such as performance values, operating hours, and switching cycles are safely transmitted between field and control level
- ✓ Easy configuration and diagnostics
- ✓ Connection to controller via bus gateway



# Application examples

## Reliable monitoring – exact and fast control

Motor managers from Phoenix Contact monitor motors for overload and underload, function, dirt, and wear. You can therefore provide permanent protection for pumps, actuating drives, fans, and machine tools, for example. The monitoring is realized by freely configurable switching and signaling thresholds. Identical or separate settings can be made for the thresholds for both directions of rotation. The active power consumed, calculated from three currents, voltages, and the phase angle, is used for parameterization. As it is independent of voltage fluctuations and drive load, the active power is thus much more precise than when just the current is taken into consideration.

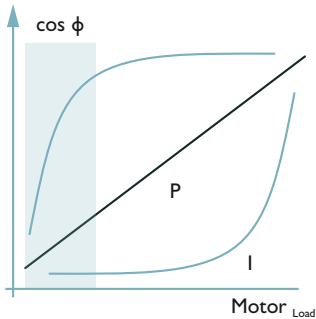
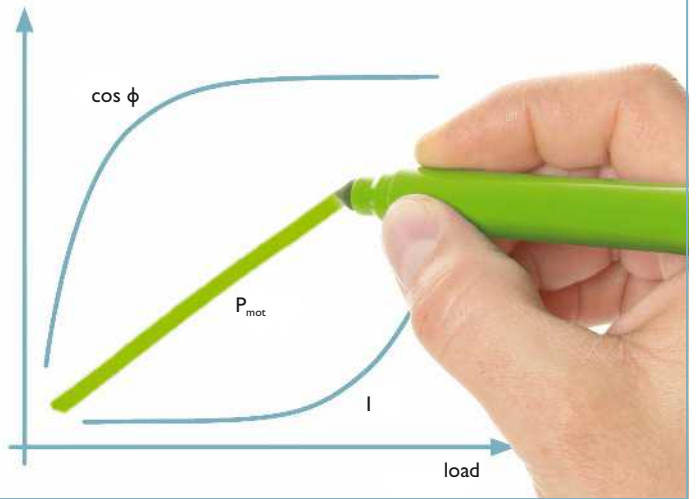

### Monitoring “lower motor load range”

The overload or underload of a motor or drive that is operated in the lower load range is optimally monitored with a cos-phi monitor.

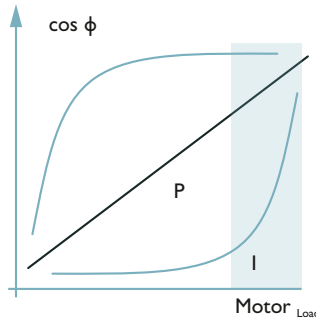

### Monitoring “optimum motor load range”

An ampere meter will suffice for monitoring the upper load range as the motor or drive is operated at an optimum cos-phi. The motor or drive should ideally be designed in this way.

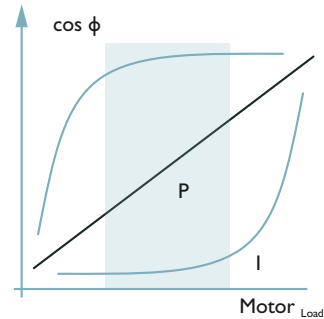

### Monitoring “middle motor load range”

However, 80% of all motors or drives operate in the middle range in which there is hardly any change to the current or cos-phi. An overload or underload is only detected reliably by a change to the recorded active power.

## Motor manager

	Input voltage	Measuring range	Motor protection	Monitoring	Internal transformer	External transformer	Network-capable	Overall width	Screw connection
	24 V DC	400 mA ... 16 A	•	•	•		•	22.5 mm	<a href="#">2297523</a>
		140 mA ... 5 A	•	•		•	•	22.5 mm	<a href="#">2297497</a>

## Motor and machine management

# Machine manager

Monitor your motors and machines: Electronic motor and machine management combines precise energy measurement with the display and monitoring of important parameters of motors, machines, or other 3-phase consumers. As an option, can be networked with all common fieldbus systems via a gateway.

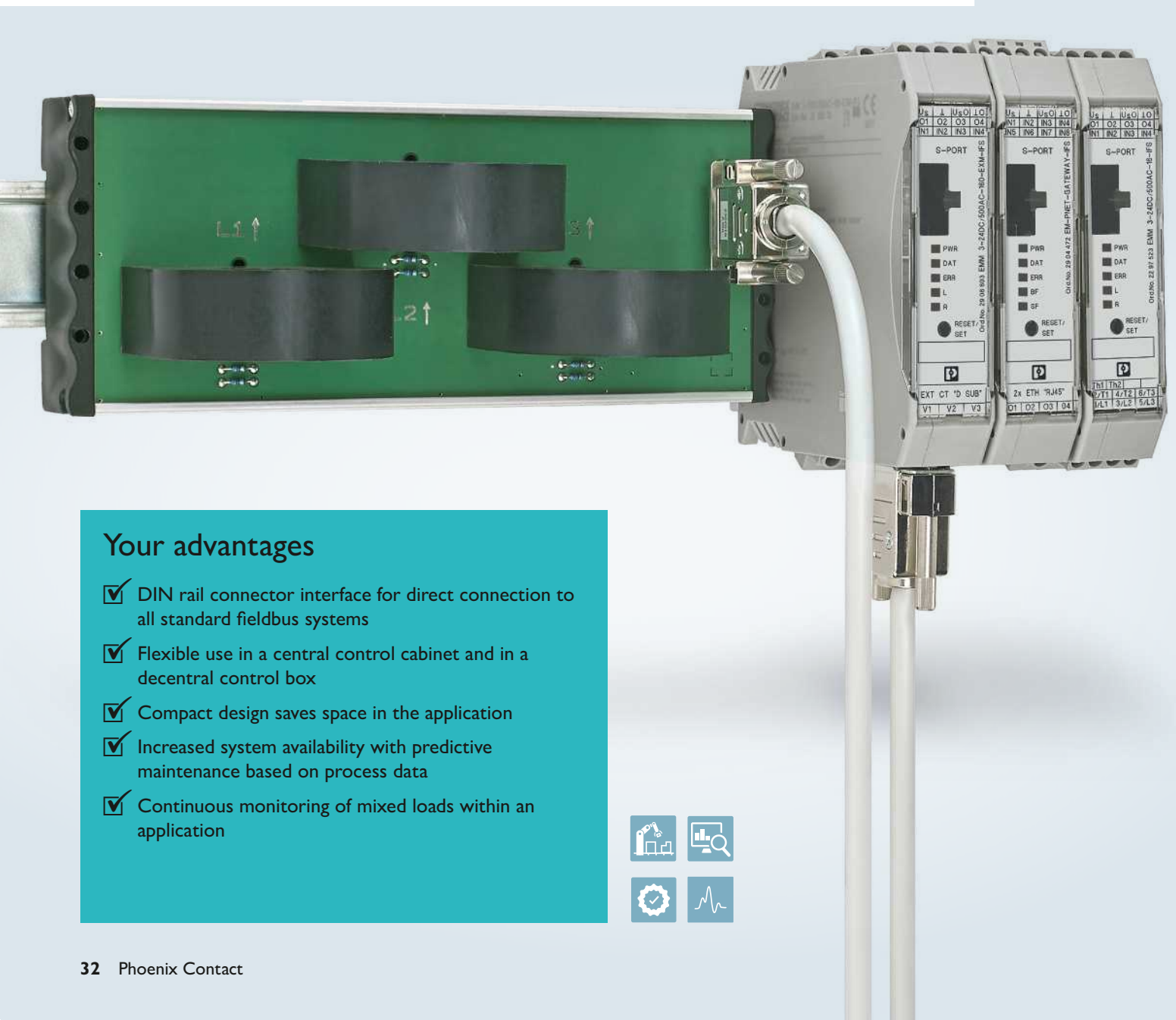

### Your advantages

- ✓ DIN rail connector interface for direct connection to all standard fieldbus systems
- ✓ Flexible use in a central control cabinet and in a decentral control box
- ✓ Compact design saves space in the application
- ✓ Increased system availability with predictive maintenance based on process data
- ✓ Continuous monitoring of mixed loads within an application





# Efficient machine management

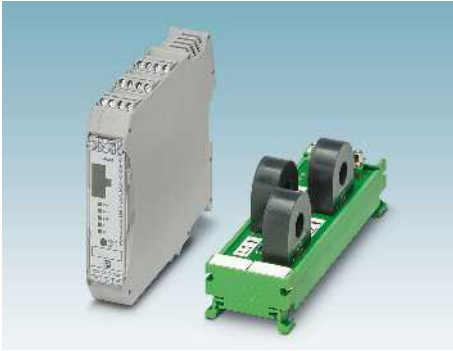

## Accurate measurements

Two versions are available with an external current transformer with current ranges up to 90 A and 160 A.



## IFS-CONF software

Benefit from the flexibility of freely configurable switching and signaling thresholds for all relevant measured variables.



## Reliable monitoring



Display of: active power, apparent power, reactive power, energy meter, cos-phi, current, voltage, frequency.

## Application example

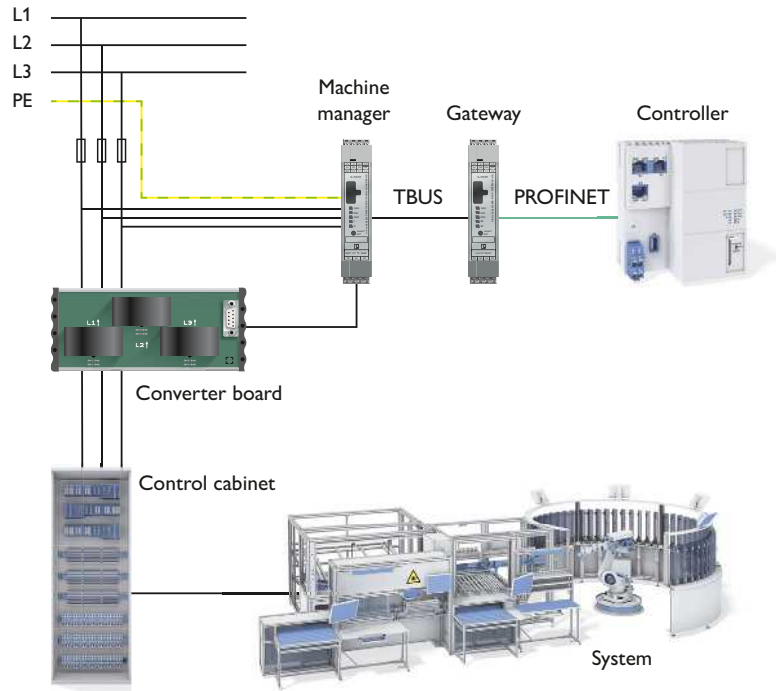
Monitoring of important machine parameters, networked via gateway and controlled via PROFINET. By combining the electronic machine manager and an external current transformer, you can cost-effectively monitor motors, machines, and 3-phase loads, including frequency converters and mixed loads. Network the machine manager with all popular fieldbus systems (PROFIBUS, PROFINET, Modbus/TCP, Ethernet, CANopen®, DeviceNet™) via a gateway. Consistent communication for Industry 4.0 with optional data transmission via OPC UA.



## Machine manager

	Input voltage	Measuring range	External transformer	Interior diameter of transformer	Network-capable	Overall width	Screw connection
	24 V DC	0.2 A ... 90 A	•	11 mm	•	22.5 mm	<a href="#">2908602</a>
		0.5 A ... 160 A	•	23 mm	•	22.5 mm	<a href="#">2908603</a>

# INTERFACE system – continuous overview of movements with digitalization and networking

The INTERFACE system consists of devices which can be connected to each other via the DIN rail connector. As the usual parallel wiring is redundant, the wiring effort is reduced.

With the flexible and modular design, the interface system always adapts to your requirements. The networking options provide an excellent basis to meet the requirements of the Internet of Things (IoT).

## Gateway for integration in the fieldbus environment

A gateway enables up to 32 devices to be networked in a fieldbus environment. In addition to protocol conversion and the coordination of devices, it serves as a data interface to the higher-level controller or cloud solution.

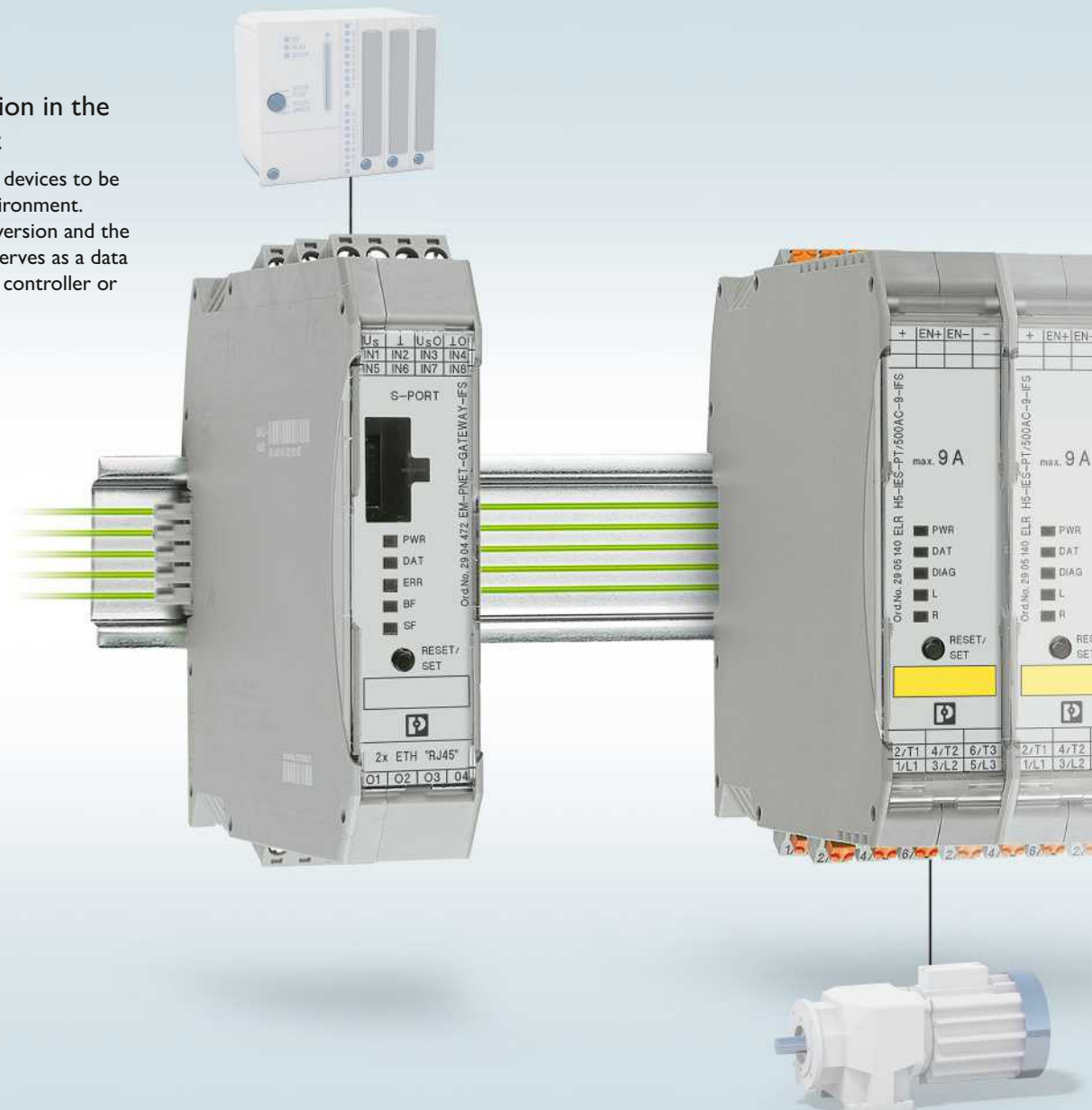

### Transfer your process data easily and network your devices quickly

The DIN rail connector (T-BUS) is the core of the interface system. It oversees the networking, communication, and power supply of the devices.

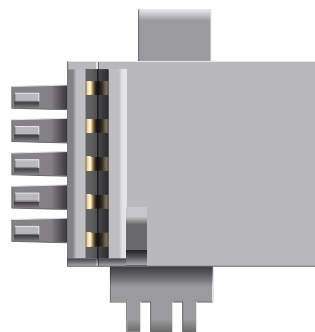

### CONTACTRON hybrid motor starters



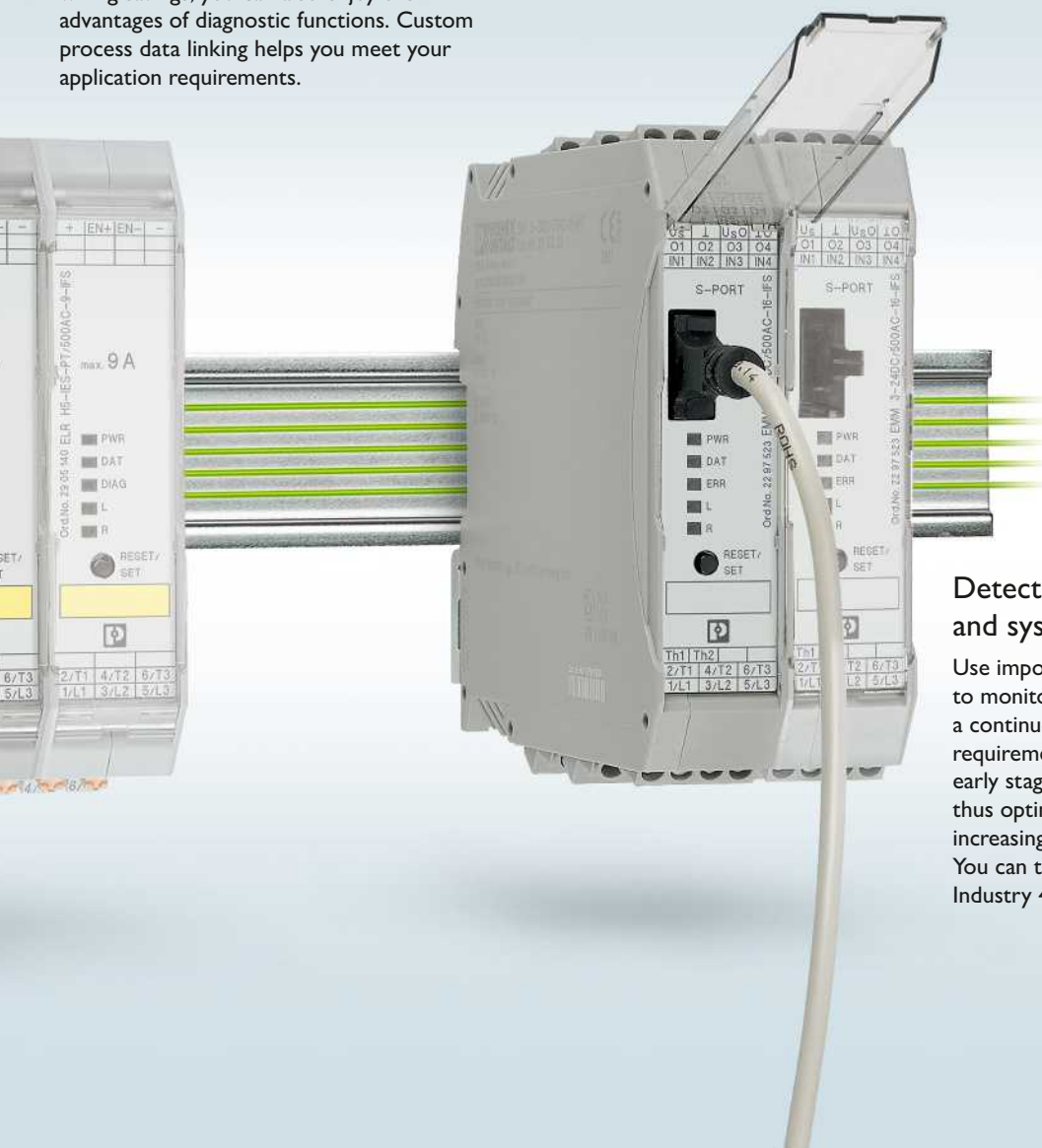

Not only do you benefit from space and wiring savings, you can also enjoy the advantages of diagnostic functions. Custom process data linking helps you meet your application requirements.



### Detect all load states of motors and systems reliably

Use important motor and system data to monitor your application. Maintain a continuous overview of your energy requirements. Detect critical load states at an early stage without using additional sensors thus optimizing maintenance cycles and increasing system availability. You can therefore meet your specific Industry 4.0 requirements.

# INTERFACE system – product overview

Gateways			
	Description	Item number	Type
	Gateway for the connection of up to 32 INTERFACE system devices to a higher-level controller via PROFIBUS DP. The INTERFACE system devices are connected to the Gateway via DIN rail connectors; the DIN rail connectors are provided.	2297620	EM-PB-GATEWAY-IFS
	Gateway for the connection of up to 32 INTERFACE system devices to a higher-level controller via CANopen®. The INTERFACE system devices are connected to the Gateway via DIN rail connectors, the DIN rail connectors are provided.	2901504	EM-CAN-GATEWAY-IFS
	Gateway for the connection of up to 32 INTERFACE system devices to a higher-level controller via PROFINET. The INTERFACE system devices are connected to the Gateway via DIN rail connectors; the DIN rail connectors are provided.	2904472	EM-PNET-GATEWAY-IFS
	Gateway for the connection of up to 32 INTERFACE system devices to a higher-level controller via Modbus/TCP. The INTERFACE system devices are connected to the Gateway via DIN rail connectors, the DIN rail connectors are provided.	2901528	EM-MODBUS-GATEWAY-IFS
	Gateway for the connection of up to 32 INTERFACE system devices to a higher-level controller via EtherNet/IP™. The INTERFACE system devices are connected to the Gateway via DIN rail connectors; the DIN rail connectors are provided.	2901988	EM-ETH-GATEWAY-IFS

# INTERFACE system – product overview

Extension module			
	Description	Item number	Type
	<p>For more complex applications with Interface system devices (IFS), the extension module offers digital inputs and outputs for processing additional signals in the field. Easy connection to an IFS gateway via the DIN rail connector as the slave.</p>	<p>2904473</p>	<p>EM-D-8/4-24DC-IFS</p>

# Power distributors

## CrossPowerSystem

CrossPowerSystem is an open platform for modular and functional control cabinets. Three-phase devices are mounted on the power distributor via Plug and Play. The 20 A power supply with integrated electronic circuit breakers (8-channel) supplies a safe 24 V supply which can be distributed easily using additional adapter rails.

### Power supply 20 A: Supply and protection

Two devices in one: The TRIO CROSS POWER 20 A power supply provides a reliable 24 V supply with additional protection by eight independent channels for shutdown in the event of errors.



**CrossPowerSystem:**  
The DIN rail with built-in power distribution

With just one click, devices are mounted on the power distribution board without tools and a safe electrical connection to the three phases immediately established – all in just one step.

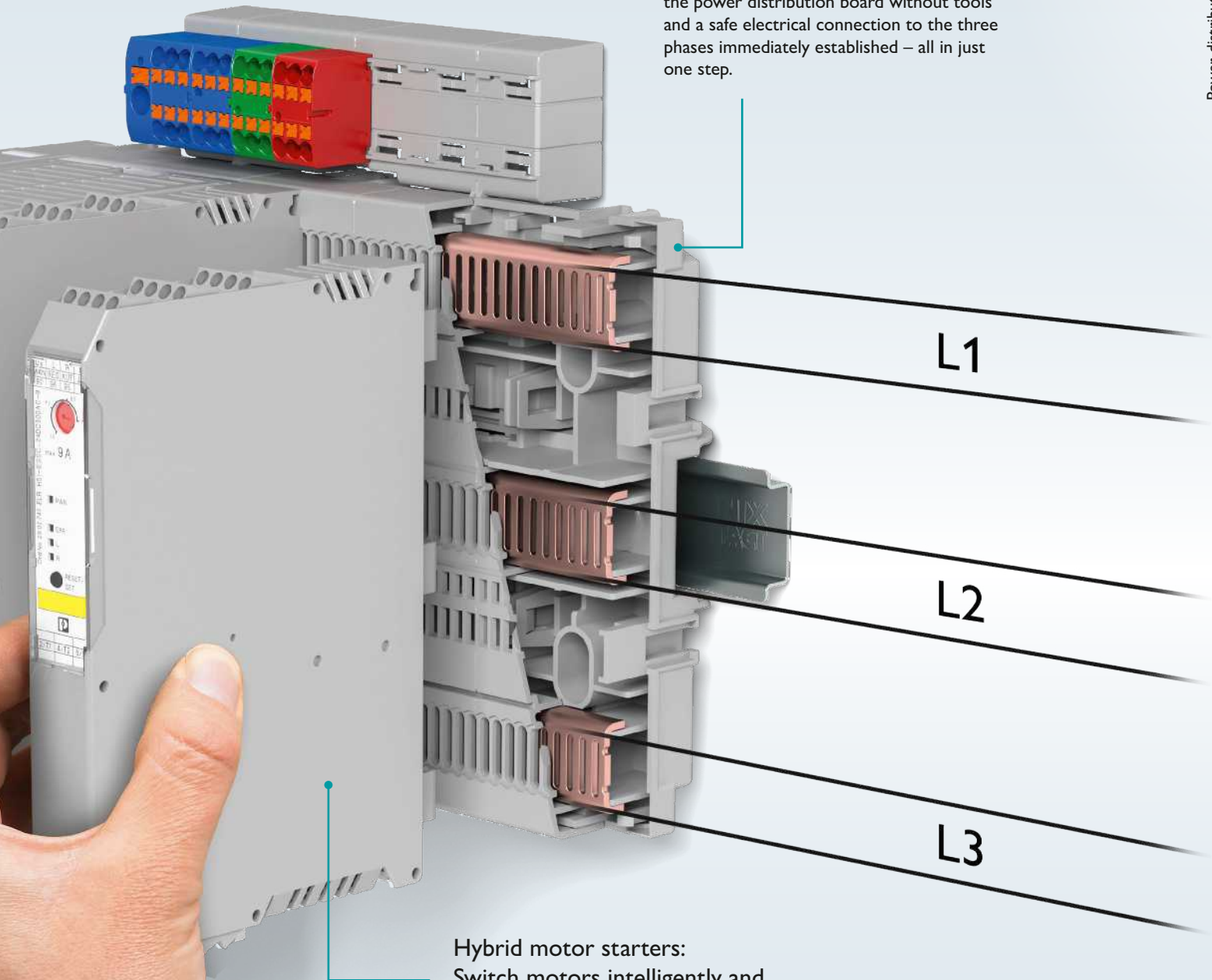

**Hybrid motor starters:**  
Switch motors intelligently and protect them safely

Four devices rolled into one: The compact hybrid motor starters with emergency stop function switch, reverse, and protect motors safely and reliably. Further devices and accessories can be integrated flexibly.

# CrossPowerSystem

## Modular and functional

We have developed a solution for 400 V distribution to simplify the wiring effort in machine and control cabinet manufacturing. With the open CrossPowerSystem platform, power supplies through to hybrid motor starters can be snapped on without the need for any tools or cables. As a result, you can configure modular and functional control cabinet solutions quickly and flexibly.

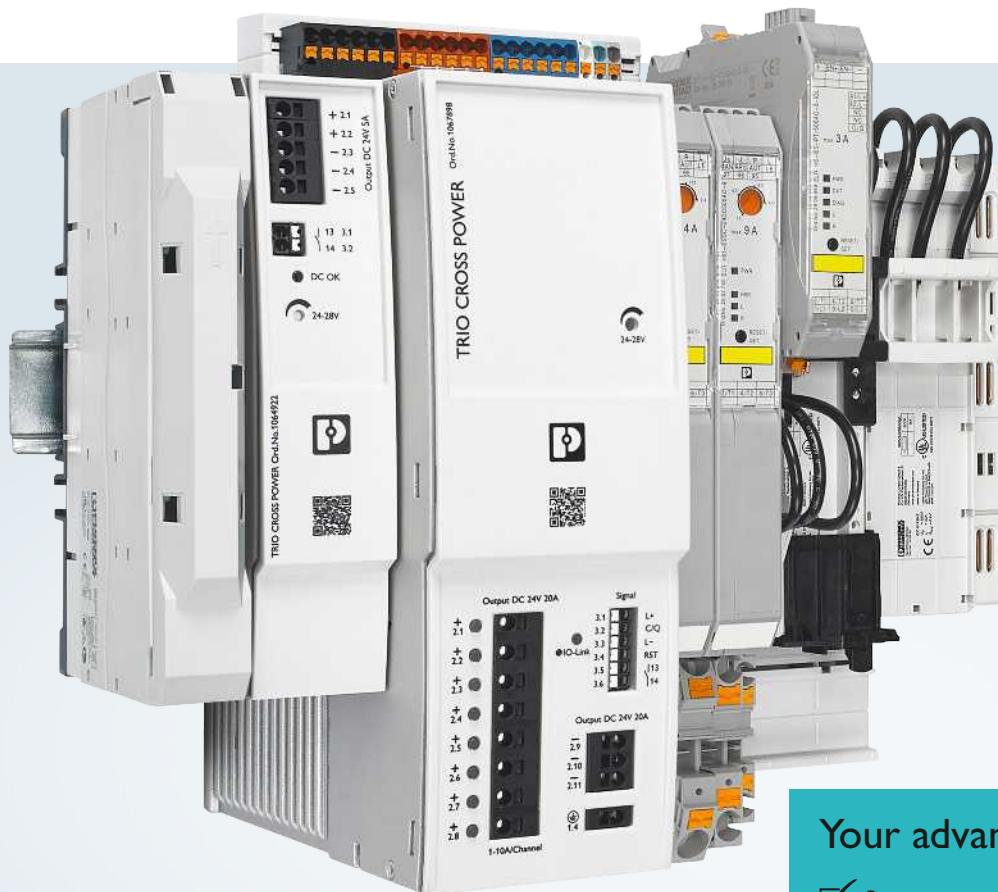

### Your advantages

- ✓ Save setup and wiring time with Plug and Play
- ✓ Save space with the compact design and flexible assembly of components
- ✓ Fuses and components can be quickly replaced, which saves servicing time
- ✓ Save costs due to modular arrangement of the control cabinet



# The perfect connection

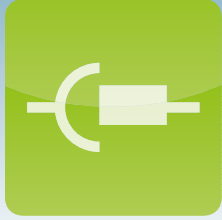

## Circuit technology and power distribution

Time is money – this is particularly true when it comes to setting up machines and systems. With the combination of power distribution and switching devices, mounting is even faster. Furthermore, the integrated reverse pole protection prevents errors and ensures even simpler startup.



## The new DIN rail with in-built power distribution

The CONTACTRON hybrid motor starter is mounted on the board without tools with just a click, and is simultaneously safely electrically connected to the three phases – all in just one step.



## Power supply



The new TRIO CROSS POWER power supply for the CrossPowerSystem power distribution board is perfectly adapted for use in machine building. All functions and the space-saving design are tailored to the stringent demands in this area. The Push-in connection allows quick and easy connection of a 24 V DC control voltage.



## Implementing modular and functional solutions



Now, reduce your wiring costs with the new 5 A power supply. This can be used to supply power to all hybrid motor starters on the board at the same time. Furthermore, to generate motor-relevant data for system monitoring, simply use the network-capable solution alongside the classic motor starters via IO-Link. A 225 mm and 405 mm version of the power distribution board is available.





# CrossPowerSystem product overview





CPS boards		
		
<b>Product type</b>	<b>Mounting adapter</b>	
<b>Description</b>	Modular power distribution board with CrossLink® interface, 125 A, 3-pos., touch-proof and protected against polarity reversal, width: 225 mm	Modular power distribution board with CrossLink® interface, 125 A, 3-pos., touch-proof and protected against polarity reversal, width: 405 mm
<b>Item number</b>	<a href="#">1002634</a>	<a href="#">1002635</a>

CPS components			
			
<b>Product type</b>	<b>Power supply</b>		<b>Switch disconnector</b>
<b>Current</b>	5 A	20 A	125 A
<b>Item number</b>	<a href="#">1064922</a>	<a href="#">1067898</a>	<a href="#">1151613</a>

CPS components			
			
<b>Product type</b>	<b>Speed starter</b>		
<b>Power</b>	0.37 kW	0.75 kW	1.5 kW
<b>Item number</b>	<a href="#">1201825</a>	<a href="#">1201829</a>	<a href="#">1201696</a>

# CrossPowerSystem product overview

CPS components			
			
<b>Product type</b>	<b>Hybrid motor starter</b>		
Network-capable	No		
Max. load current	0.6 A	2.4 A	9 A
Item number	2902746	2902744	2902745

CPS components						
						
<b>Product type</b>	<b>Hybrid motor starter</b>				<b>Bridge</b>	
Network-capable	IO-Link		INTERFACE system			
Max. load current	3 A	9 A	3 A	9 A		
Item number	1151617	1151610	1151618	1151587	1191990	

# CrossPowerSystem product overview

CPS accessories			
	Description	Item number	Type
	Adapter rail for the CrossPowerSystem power distribution board with mounting for PTFIX distribution blocks	1119251	EM-CPS-PTFIX-135
	Adapter rail for the CrossPowerSystem power distribution board with integrated DIN rail for mounting distributor terminal blocks up to 35 mm <sup>2</sup>	1119259	EM-CPS-NS35-135
	Adapter for CONTACTRON Speed Starter for direct mounting on the CrossPowerSystem power distribution board	1282859	EM-CPS-DA-45C-CSS
	Connection module with integrated spring-loaded terminals for cables from 1.5 to 16 mm <sup>2</sup> , 3-pos., maximum 63 A	1002633	EM-CPS-TB3/63A
	Connection module with box terminals for conductors from 6 to 50 mm <sup>2</sup> , 3-pos., maximum 125 A	1070299	EM-CPS-TB3/125A
	Single-position adapters with CrossLink® interface for connecting miniature circuit breakers, 16 A, phase L1, with one fixed DIN rail, with conductors AWG 14 (2.5 mm <sup>2</sup> )	1089439	EM-CPS-DA-18S/16A-L1
	Single-position adapters with CrossLink® interface for connecting miniature circuit breakers, 16 A, phase L2, with one fixed DIN rail, with conductors AWG 14 (2.5 mm <sup>2</sup> )	1089440	EM-CPS-DA-18S/16A-L2
	Single-position adapters with CrossLink® interface for connecting miniature circuit breakers, 16 A, phase L3, with one fixed DIN rail, with conductors AWG 14 (2.5 mm <sup>2</sup> )	1089441	EM-CPS-DA-18S/16A-L3
	Single-position adapters with CrossLink® interface for connecting miniature circuit breakers, 63 A. Phase L1, with one fixed DIN rail, with conductors AWG 8 (10 mm <sup>2</sup> )	1089356	EM-CPS-DA-18S/63A-L1
	Single-position adapters with CrossLink® interface for connecting miniature circuit breakers, 63 A. Phase L2, with one fixed DIN rail, with conductors AWG 8 (10 mm <sup>2</sup> )	1089442	EM-CPS-DA-18S/63A-L2
	Single-position adapters with CrossLink® interface for connecting miniature circuit breakers, 63 A. Phase L3, with one fixed DIN rail, with conductors AWG 8 (10 mm <sup>2</sup> )	1089446	EM-CPS-DA-18S/63A-L3

# CrossPowerSystem product overview

CPS accessories			
	Description	Item number	Type
	Device adapter with fuse holder for 16 A fuse (10x38 / Class CC), CrossLink® interface and a fixed DIN rail	1002668	EM-CPS-DA-22,5F/16A
	Standard device adapter with CrossLink® interface and a fixed DIN rail, rated current: 16 A	1003291	EM-CPS-DA-45S/16A
	Standard device adapter with CrossLink® interface and a fixed DIN rail, rated current: 32 A	1003292	EM-CPS-DA-45S/32A
	Comfort device adapter with CrossLink® interface and a moveable DIN rail, rated current: 16 A	1002666	EM-CPS-DA-45C/16A
	Comfort device adapter with CrossLink® interface and a moveable DIN rail, rated current: 25 A	1002665	EM-CPS-DA-45C/25A
	Comfort device adapter with CrossLink® interface and a moveable DIN rail, rated current: 32 A	1002664	EM-CPS-DA-45C/32A
	Comfort device adapter with CrossLink® interface and a moveable DIN rail, rated current: 45 A	1003289	EM-CPS-DA-45C/45A
	Height extension for Comfort device adapter, width: 45 mm	1003293	EM-CPS-DAE-45
	Lateral extension of the height extension for Comfort device adapter, width: 45 mm	1003294	EM-CPS-DAES-45
	Comfort DIN rail, additional DIN rail for Comfort device adapter	1003295	EM-CPS-TS-45
	Siemens device mount, positioning element for Siemens S0 and S00 switching devices	1003296	EM-CPS-DHS-45
	Eaton device mount, positioning element for Eaton PKZ switching devices	1002663	EM-CPS-DHE-45

# COMPLETE line – the comprehensive solution for the control cabinet

The COMPLETE line system encompasses technologically leading and coordinated hardware and software products, consulting services, and system solutions that help you optimize your processes in control cabinet manufacturing. Engineering, purchasing, installation, and operation become significantly easier for you.

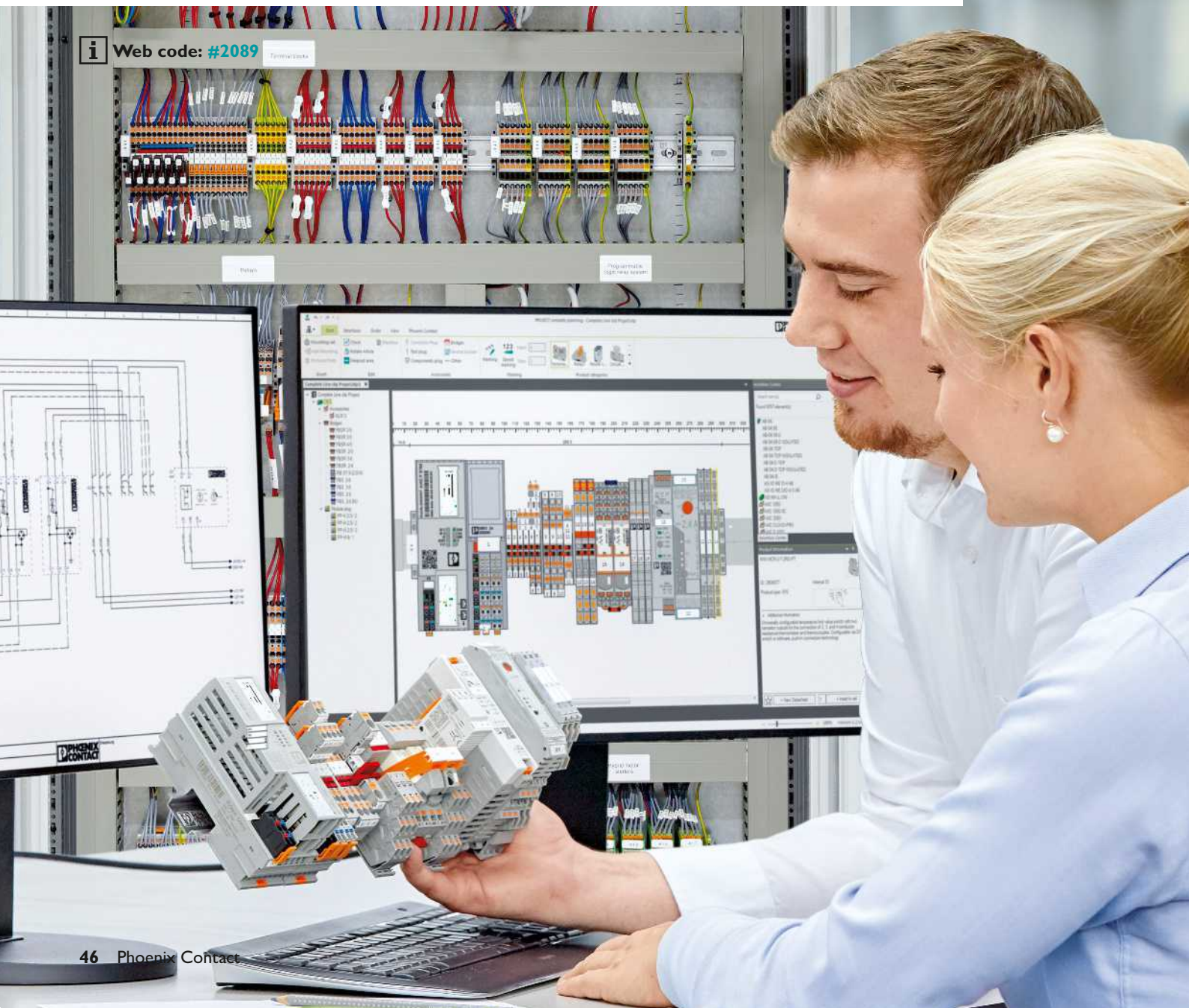

## Your advantages in detail:



### Comprehensive product portfolio

With COMPLETE line, we offer a complete product portfolio of technologically leading products. This includes:

- Controllers and I/O modules
- Power supplies and device circuit breakers
- Terminal blocks and distribution blocks
- Relay modules and motor starters
- Signal conditioners
- Safety technology
- Surge protection
- Heavy-duty connectors



### Intuitive handling

With the simple, intuitive handling of the coordinated hardware components, you will save time during installation, commissioning, and maintenance. With Push-in connection technology, you can wire applications quickly and without using tools. The broad, technologically leading product portfolio will always provide you with the right product for standard or special applications.



### Save time throughout the entire engineering process

The clipx ENGINEER complete planning and marking software supports the entire process of control cabinet manufacturing. The program features an intuitive user interface that allows the individual planning, automatic checking, and direct ordering of terminal strips.



### Reduced logistics costs

Reduced variety of parts with standardized marking, bridging, and testing accessories. The COMPLETE line system coordinates products, design, and accessories so that you benefit from maximum reusability and thus reduce your logistics costs.



### Optimized processes in control cabinet manufacturing

COMPLETE line supports you, from engineering through to manufacturing, in designing your control cabinet production as efficient as possible. This is how your customized concept for optimizing your processes in control cabinet manufacturing is created. Our terminal strip production helps you to flexibly manage order peaks or to supply your control cabinet production with fully assembled DIN rails just in time.

# Ongoing communication with customers and partners worldwide

Phoenix Contact is a global, market leader based in Germany. Our group is known for its future-oriented components, systems, and solutions in the fields of electrical engineering, electronics, and automation.

With a global network reaching across more than 100 countries and 17,400 employees, we can stay in close contact with our customers, something we believe is essential to success. The wide variety of our innovative products makes it easy for our customers to find future-oriented solutions for multiple applications and industries. We especially focus on the fields of energy, infrastructure, process, and factory automation.

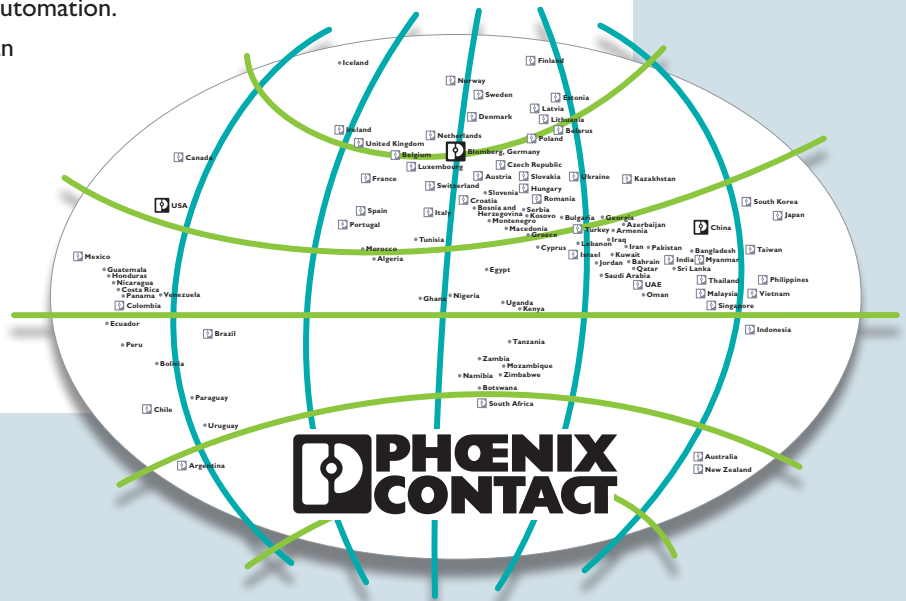

You will find our complete product range at:  
[www.phoenixcontact.com.au](http://www.phoenixcontact.com.au)

PHOENIX CONTACT Pty. Ltd.

## SYDNEY Head Office

Unit 7, 2-8 South Street  
 RYDALMERE NSW 2116  
 Phone: 1300 786 411  
 Fax: 1300 723 399  
 E-mail: [customerservice@phoenixcontact.com.au](mailto:customerservice@phoenixcontact.com.au)  
 Website: [www.phoenixcontact.com.au](http://www.phoenixcontact.com.au)

## MELBOURNE

Unit 1 8-12 Butler Way  
 TULLAMARINE 3043 VIC  
[vicsales@phoenixcontact.com.au](mailto:vicsales@phoenixcontact.com.au)

## BRISBANE

Unit 9, 56 Lavarack Avenue  
 EAGLE FARM 4009 QLD  
[customerservice@phoenixcontact.com.au](mailto:customerservice@phoenixcontact.com.au)

## ADELAIDE

12B Main Assembly Bldg, Tonsley Park  
 1284 South Road  
 TONSLEY SA 5042  
[customerservice@phoenixcontact.com.au](mailto:customerservice@phoenixcontact.com.au)

## PERTH

Unit 5, 175 Campbell Street  
 BELMONT WA 6104  
[wasaes@phoenixcontact.com.au](mailto:wasaes@phoenixcontact.com.au)

**LIFETIME WARRANTY**  
 BUILD WITH CONFIDENCE

**PRICE GUARANTEE**  
 BUILD WITH CONFIDENCE

**IN-STOCK GUARANTEE**  
 BUILD WITH CONFIDENCE

**ESHOP PLATFORM**  
 BUILD WITH CONFIDENCE

**INDUSTRY 4.0**  
 BUILD WITH CONFIDENCE